

Electronic level switch with display

Model LSD-30

TC Fluid Control data sheet LM 40.01

Applications

- Machine tools
- Hydraulic aggregates
- Tank monitoring
- Machine building

Special features

- Easily-readable, robust display
- Intuitive and fast setup
- Easy and flexible mounting configurations

Description

Award-winning in design and functionality

The successful design and the excellent functionality of the WIKA switch family were already confirmed by winning the "iF product design award 2009" for the pressure switch model PSD-30.

The robust LED display has been designed using 9 mm high characters (the largest possible) and with a slight incline in order to make reading the level as easy as possible from a long way off. A 14-segment display has been used, since it represents text very well.

The 3-key operation makes simple, intuitive menu navigation possible, with no need for additional assistance. The menu navigation is designed in accordance with the latest VDMA standard. The VDMA standard for fluid sensors (24574-4, part 4 - level switches) has the aim of considerably simplifying the use of level switches by standardising menu navigation and display.

The control keys have been designed as large as possible and are arranged ergonomically to ensure fast and easy adjustments. Operation without any additional assistance is made easier through the tactile feedback.



Electronic level switch with display
Model LSD-30

Customised installation

The installation of the model LSD-30 level switch can be flexibly adapted to the individual mounting situation. Due to the almost unlimited rotation of the display and case by more than 300°, the display can be adjusted independently of the electrical connection. The display can thus always be aligned to face the operator, and the M12 x 1 connection positioned to suit the desired cable routing.

High quality

During development of the WIKA switch family a high value was placed on a robust design and the selection of appropriate materials suited to machine-building applications. For this reason the case and the threaded connection of the electrical connector are made from stainless steel. Overwinding or tearing off the connector is therefore virtually impossible.

Measuring ranges

for process connection G 3/4 A

Sensor length F (mm)	250	370	410	520	730
Measuring range (mm)	189	309	349	459	669
Measuring range (inch)	7.44	12.17	13.74	18.07	26.34

for process connection 3/4 NPT

Sensor length F (mm)	250	370	410	520	730
Measuring range (mm)	205	325	365	475	684
Measuring range (inch)	8.07	12.80	14.37	18.70	26.93

Insertion lengths see "Dimensions in mm"

Specific gravity range of the medium

≥ 0.7 g/cm³

Output signal

Switching output		Analogue signal
SP1	SP2	
PNP	-	4 ... 20 mA (3-wire)
PNP	-	DC 0 ... 10 V (3-wire)
PNP	PNP	-
PNP	PNP	4 ... 20 mA (3-wire)
PNP	PNP	DC 0 ... 10 V (3-wire)

Optionally also available with an NPN instead of a PNP switching output.

Switching thresholds

Switch point 1 and 2 are both individually adjustable

Switching functions

Normally open, normally closed, window, hysteresis
Freely adjustable

Switching voltage

Power supply - 1 V

Switching current

max. 250 mA per switching output

Adjustment accuracy

2.5 mm steps

Response time

< 200 ms

Lettering (display and analogue signal)

Zero point: max. +25 % of span

Full scale: max. -25 % of span

Offset adjustment (display)

max. +1,500 mm

Load

- Analogue signal 4 ... 20 mA: ≤ 500 Ω
- Analogue signal DC 0 ... 10 V: > 10 kΩ

Display

14-segment LED, red, 4-digit, character size 9 mm

Display can be turned electronically through 180°

Update

200 ms

Voltage supply

Power supply U_s

DC 15 ... 35 V

Current consumption

Switching outputs with

- Analogue signal 4 ... 20 mA: 70 mA
- Analogue signal DC 0 ... 10 V: 45 mA
- without analogue signal: 45 mA

Total current consumption

max. 600 mA (incl. switching current)

Measuring element

Resistance measuring chain with reed switches and float

Resolution

< 6 mm

Response time

< 700 ms

Maximum operating pressure

3 bar

Media compatibility

Test following ISO 7620, section 6, table 1

Medium		Standard
Mineral oil	HLP	per DIN 51524
Aqueous solution	HFC	per VDMA 24317
Organic ester	HFD-U	per VDMA 24317
Triglyceride (rape oil)	HETG	per VDMA 24568
Synthetic ester	HEES	per VDMA 24568
Polyglycols	HEPG	per VDMA 24568

Accuracy data

Switching output

1 % of span

Display

1 % of span ±1 digit

Analogue signal

≤ ±0.5 % of span

Reference conditions

Temperature:	15 ... 25 °C
Atmospheric pressure:	950 ... 1,050 mbar
Humidity:	45 ... 75 % r. h.
Nominal position:	Process connection lower mount (LM)
Power supply:	DC 24 V
Load:	see "Output signal"

Operating conditions

Permissible temperatures

Medium:	-20 ... +80 °C
Ambient:	-20 ... +80 °C
Storage:	-20 ... +80 °C

Humidity

45 ... 75 % r. h.

Mounting position

vertical

Process connections

Available connections

Standard	Thread
DIN 3852-E	G 3/4 A
ANSI / ASME B1.20.1	3/4 NPT

Other connections on request.
Details on the sensor dimensions see "Dimensions in mm".

Sealings

for connections per DIN 3852-E	
Standard	NBR
Option	Without
Option	FPM/FKM

Materials

Wetted parts

Level sensor:	Stainless steel 316Ti
Float:	NBR (see "Media compatibility")

Non-wetted parts

Case:	Stainless steel 304
Keyboard	TPE-E
Display window:	PC
Display head:	PC+ABS-Blend

Electrical connections

Connections

- Circular connector M12 x 1, 4-pin
- Circular connector M12 x 1, 5-pin ¹⁾

1) Only for version with two switching outputs and additional analogue signal

Ingress protection

IP 65 and IP 67

The stated ingress protection (per IEC 60529) only applies when plugged in using mating connectors that have the appropriate ingress protection.

Electrical safety

Short-circuit resistance:	S+ / SP1 / SP2 vs. U-
Reverse polarity protection:	U+ vs. U-
Insulation voltage:	DC 500 V
Overvoltage protection:	DC 40 V

Connection diagram

Circular connector M12 x 1 (4-pin)

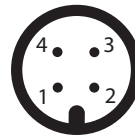

U+	1
U-	3
S+	2
SP1	4
SP2	2

Circular connector M12 x 1 (5-pin)



U+	1
U-	3
S+	5
SP1	4
SP2	2

Legend:

U+	Power supply
U-	Reference potential
SP1	Switching output 1
SP2	Switching output 2
S+	Analogue output

Dimensions in mm

Level switch

with M12 x 1 circular connector
4-pin / 5-pin

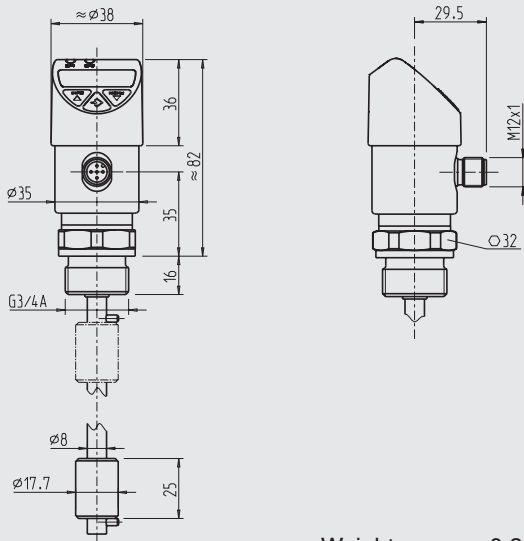

Weight: approx. 0.3 kg

CE conformity

EMC directive

2004/108/EC, EN 61326-2-3 emission (group 1, class B) and interference immunity (industrial application)

RoHS conformity

2011/65/EU

Process connections

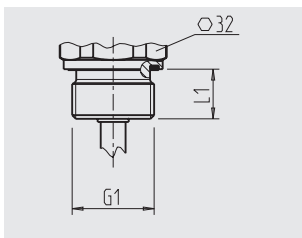

G1	L1
G 3/4 A DIN 3852-E	16

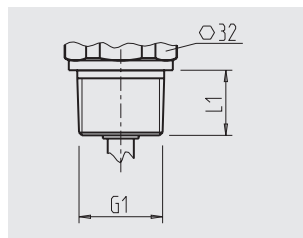

G1	L1
3/4 NPT	20

Insertion lengths

Parallel thread

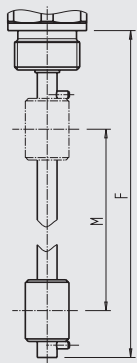

F	M
250	189
370	309
410	349
520	459
730	669

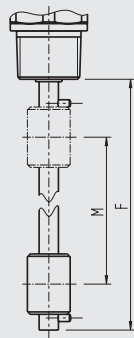

Tapered thread



F	M
250	205
370	325
410	365
520	475
730	684

Accessories and spare parts

Sealings		
	Description	Order no.
	NBR profile sealing G 3/4 DIN 3852-E	1100378
	FPM / FKM profile sealing G 3/4 DIN 3852-E	1158309

Connectors with moulded cable				
	Description	Temperature range	Cable diameter	Order no.
	Straight version, cut to length, 4-pin, 2 m PUR cable, UL listed, IP 67	-20 ... +80 °C	4.5 mm	14086880
	Straight version, cut to length, 4-pin, 5 m PUR cable, UL listed, IP 67	-20 ... +80 °C	4.5 mm	14086883
	Straight version, cut to length, 4-pin, 10 m PUR cable, UL listed, IP 67	-20 ... +80 °C	4.5 mm	14086884
	Straight version, cut to length, 5-pin, 2 m PUR cable, UL listed, IP 67	-20 ... +80 °C	5.5 mm	14086886
	Straight version, cut to length, 5-pin, 5 m PUR cable, UL listed, IP 67	-20 ... +80 °C	5.5 mm	14086887
	Straight version, cut to length, 5-pin, 10 m PUR cable, UL listed, IP 67	-20 ... +80 °C	5.5 mm	14086888
	Angled version, cut to length, 4-pin, 2 m PUR cable, UL listed, IP 67	-20 ... +80 °C	4.5 mm	14086889
	Angled version, cut to length, 4-pin, 5 m PUR cable, UL listed, IP 67	-20 ... +80 °C	4.5 mm	14086891
	Angled version, cut to length, 4-pin, 10 m PUR cable, UL listed, IP 67	-20 ... +80 °C	4.5 mm	14086892
	Angled version, cut to length, 5-pin, 2 m PUR cable, UL listed, IP 67	-20 ... +80 °C	5.5 mm	14086893
	Angled version, cut to length, 5-pin, 5 m PUR cable, UL listed, IP 67	-20 ... +80 °C	5.5 mm	14086894
	Angled version, cut to length, 5-pin, 10 m PUR cable, UL listed, IP 67	-20 ... +80 °C	5.5 mm	14086896

Ordering information

Model / Sensor length F / Output signal / Process connection / Sealing / Accessories and spare parts

© 2012 WIKA Alexander Wiegand SE & Co. KG, all rights reserved.
The specifications given in this document represent the state of engineering at the time of publishing.
We reserve the right to make modifications to the specifications and materials.